

TECHNICAL DATASHEET



EF ELBOW 90°

04 Update - 06/2023

TECHNICAL DATA

Article No	101 117 2021 0075
d (mm)	75
D (mm)	95
Z (mm)	141
le (mm)	53
m (mm)	27,3
Weight (Kg)	0,436
Box Quantity (pcs)	16
Box Dimension (cm)	31x50x34

INJECTION MOULDED

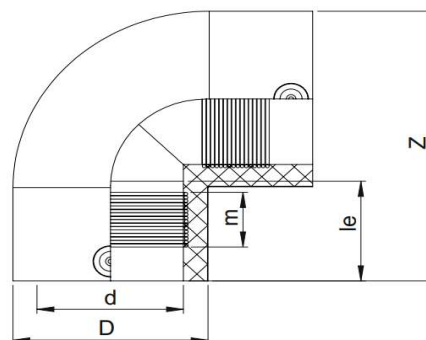

IDENTIFICATION OF PRODUCT

D(mm)	75
SDR	11
RAW MATERIAL	PE 100
PRESSURE CLASS	16 Bar Water 10 Bar Gas
TRADEMARK	NTG
EXECUTION	Injection Moulded
STANDARD	EN 12201-3 EN 1555-3 AS / NZS 4129
SPECIFICATION	Suitable for SDR11...17 pipe 4 mm pin connectors

EF SPECIFICATION

WELDING VOLTAGE	40 V
RESISTANCE	1,2 Ω
WELDING TIME	70 Sec.
COOLING TIME	5 Min.
WINDING TYPE	Monofilar
WELDING BARCODE	



981420300753991205070111

Tolerance on diameters and thickness according to the standards. The other dimensions are specialized. Tolerance $\pm 5\%$. NTG PLASTIK reserves all the right to change any information without giving prior notice. The production, distribution and utilization of this document without explicit authorization is prohibited.